

# OUTDOOR TABLES & BASES

STRAND  
HOSPITALITY FURNITURE

COLLECTION 2024



# CONTENTS

---

## COMPLETE TABLES

|            |   |
|------------|---|
| AVERY      | 3 |
| NOVAK      | 4 |
| ZOEY       | 5 |
| KUBIK LILY | 6 |
|            | 7 |

## STANDARD & FOLDING BASES

|         |    |
|---------|----|
| DYNA    | 8  |
| KANSAS  | 9  |
| MATLOCK | 10 |
| PENRITH | 11 |
| LAURENT | 12 |
| CONDOR  | 13 |
| NAROBÉ  | 14 |



# AVERY | COFFEE TABLES |



Made in Italy



Outdoor Use



Warranty 24 months

The Avery coffee table is a simple design manufactured from polypropylene and is uniformly coloured with an anthracite, white or taupe finish. It features non slip feet and has UV additives making it an ideal outdoor table. It also goes well with the Avery Armchair.

[VIEW SPECS](#)



TABLE 600MM



TABLE 1000MM X 600MM

# NOVAK | COFFEE TABLE |



Made in Italy



Outdoor Use



Warranty 24 months

The Novak table is made from fibreglass polypropylene. Available in anthracite or white, this table is perfect for around the pool, casual dining areas and resort environments. The Novak table can be paired with a variety of different chair shapes and benches that are also available in the Novak range from Nardi Outdoor.

[VIEW SPECS](#)



COFFEE TABLE



NOVAK

# ZOEY | TABLE |



Made in Italy



Outdoor Use



Warranty 24 months

The Zoey Table is a superior outdoor table made from polypropylene reinforced with fiberglass. Available in anthracite, white or taupe, this table is designed for the outdoors in hospitality or accommodation settings.

[VIEW SPECS](#)



TABLE 800MM

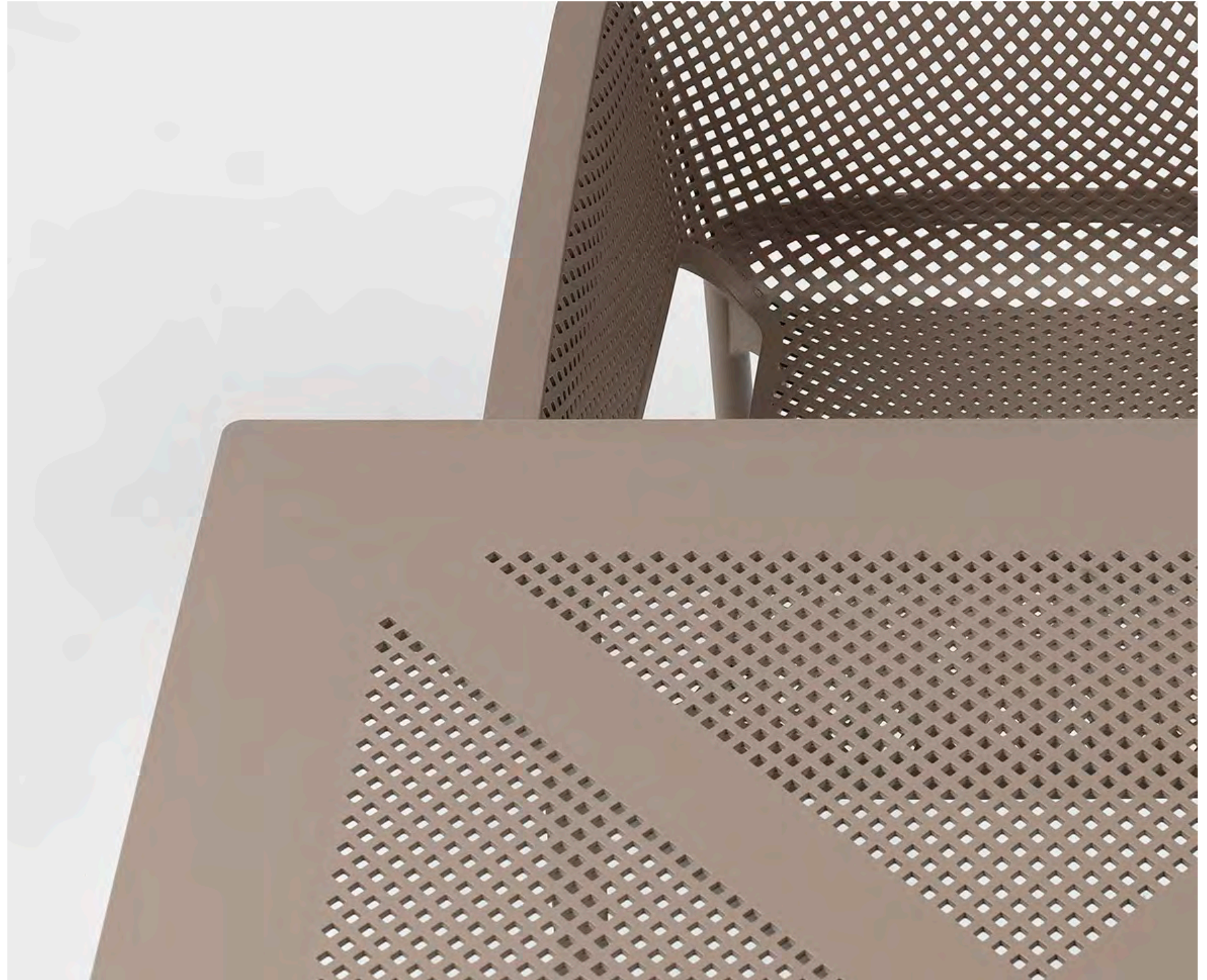

ZOEY

# KUBIK | TABLES |



Made in Italy



Outdoor Use



Warranty 24 months

The Kubik table and drybar are both sleek and contemporary in design, featuring an anthracite, white or taupe finish. They are made from a UV resistant polypropylene resin top and powdercoated aluminium base. The table converts into the drybar by adding a section to the bottom.

[VIEW SPECS](#)



BAR TABLE 800MM



TABLE 800MM



TABLE 1400MM x 800MM

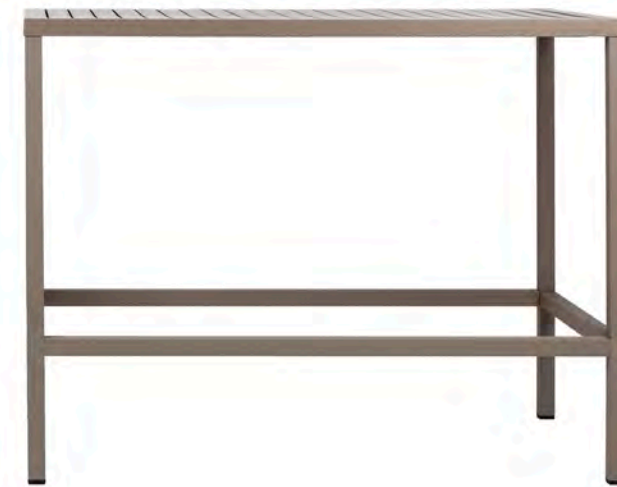

BAR TABLE 1400MM x 800MM



KUBIK

# LILY | TABLE |



Made in Italy



Outdoor Use



Warranty 24 months

The Lily table is supplied in kit form to allow you to assemble the 2 heights (coffee table or table). Made from recyclable polypropylene, this functional table features small perforations in the top for drainage. This table is ideal in accommodation applications especially on balconies.

[VIEW SPECS](#)



TABLE (40CM HEIGHT CONFIGURATION)



TABLE (76.5CM HEIGHT CONFIGURATION)



# DYNA | BASES |



Made in Italy



Outdoor Use



Warranty 24 months

The Dyna table & dry bar feature a zinc coated cast iron base with a powdercoated aluminium column. These bases have a small foot print, solid weight and are ideal for all outside hospitality applications.

[VIEW SPECS](#)



TABLE

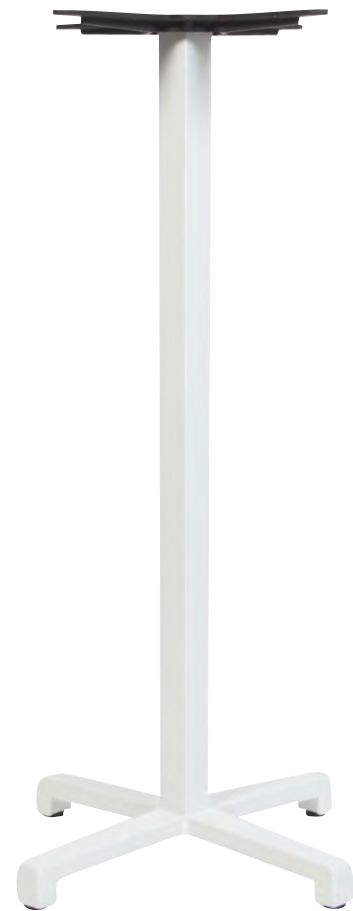

DRYBAR



DYNA





# KANSAS | TABLE & BAR TABLES BASES |



Made in Italy



Indoor and Outdoor Use



Warranty 24 Months

The Kansas table base is an indoor and outdoor base with minimal and refined features. It has a look that allows versatile contract applications and can be combined with tops of different sizes to stand out as a square base.

[VIEW SPECS](#)



TABLE BASE

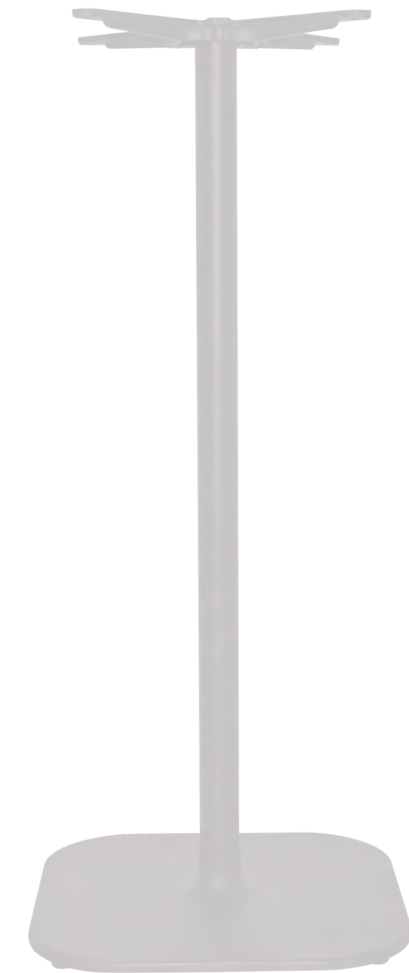

BAR TABLE BASE

# MATLOCK | TABLE & DRYBAR BASE |



Made in Italy



Indoor and Outdoor Use



Warranty 24 months

This base is one of our first aluminium powder coated bases from Nardi, Italy. This CATAS tested semi-outdoor base is initially available in the anthracite colour. It is ideal for hotel, club, cafe or restaurant environments with its smooth texture and slim design.

[VIEW SPECS](#)



TABLE BASE



BAR TABLE BASE





# PENRITH | FOLDING TABLE & BAR TABLES BASES |



first Made in Italy



Indoor and Outdoor Use



Warranty 24 Months

The Penrith bases are streamline and feature soft curves in the base design. The base is one of our aluminium powder coated folding bases from Nardi, Italy. It is a semi outdoor base, CATAS tested and has a reinforced aluminium spider with handle for easy manoeuvrability and is stackable sideways for compact storage.

[VIEW SPECS](#)



TABLE BASE



BAR TABLE BASE



# LAURENT | BASES |



Made in China



Outdoor Use



Warranty 12 months

The Laurent table and drybar bases are made from cast aluminium with a black gloss finish. They are a modern yet vintage style base and perfect for the boutique cafe and accommodation environments.

[VIEW SPECS](#)



TABLE



HEAVY DUTY TABLE

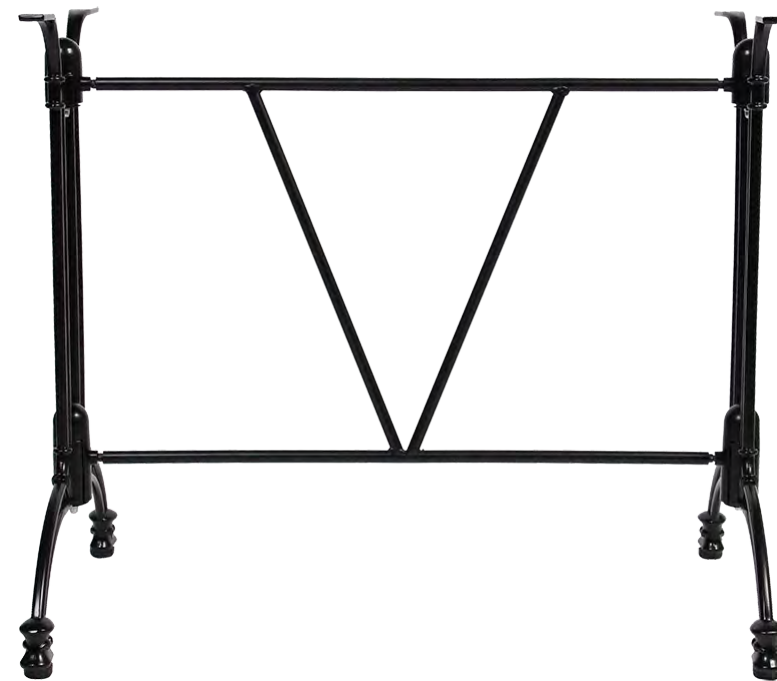

2 WAY TABLE



DRYBAR



HEAVY DUTY DRYBAR

[RETURN TO TOP](#)

LAURENT

# CONDOR | BASES |



Made in China



Outdoor Use



Warranty 12 months

The Condor table and drybar bases are powder coated aluminium frames in an anthracite finish. These bases are ideal in outdoor settings specifically in hospitality.

[VIEW SPECS](#)



TABLE



2 WAY TABLE



DRYBAR



# NAROBÉ | BASES |



Made in China



Outdoor Use



Warranty 12 months

The Narobe table and drybar is made from aluminium with an anthracite powdercoated finish. It has a cast aluminium spider and features a folding mechanism for easy storage.

[VIEW SPECS](#)



TABLE



2 WAY TABLE



BAR

## COFFEE TABLE

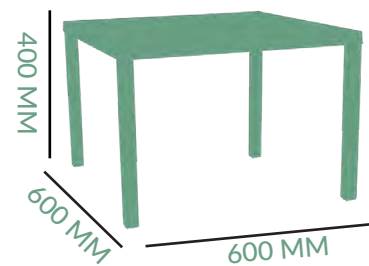

## DIMENSIONS



5 KG

**FRAME:** FIBREGLASS  
POLYPROPYLENE

**COLOUR OPTIONS:**  
ANTHRACITE  
TAUPE  
WHITE

TESTED:

[VIEW TEST](#)

- SUPPLIED IN KD FORM
- UV ADDITIVES
- OTHER COLOURS AVAILABLE VIA INDENT

## EXTRA INFORMATION

## COFFEE TABLE

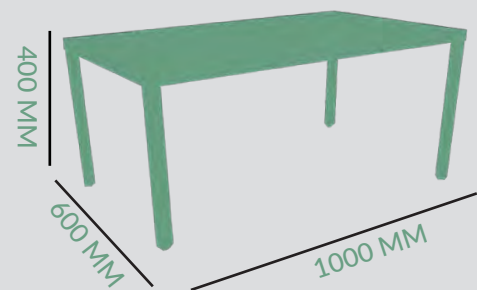

## DIMENSIONS



8 KG

**FRAME:** FIBREGLASS  
POLYPROPYLENE

**COLOUR OPTIONS:**  
ANTHRACITE  
TAUPE  
WHITE

TESTED:

[VIEW TEST](#)

- SUPPLIED IN KD FORM
- UV ADDITIVES
- OTHER COLOURS AVAILABLE VIA INDENT

## EXTRA INFORMATION

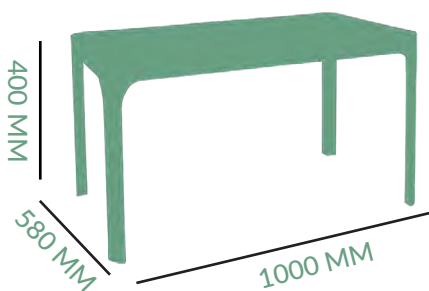

## DIMENSIONS



6.3 KG

**FRAME:** FIBREGLASS  
POLYPROPYLENE

**COLOUR OPTIONS:**  
ANTHRACITE  
WHITE

TESTED:

[VIEW TEST](#)

- SUPPLIED IN KD FORM
- UV ADDITIVES
- OTHER COLOURS AVAILABLE VIA INDENT

## EXTRA INFORMATION

800 TABLE

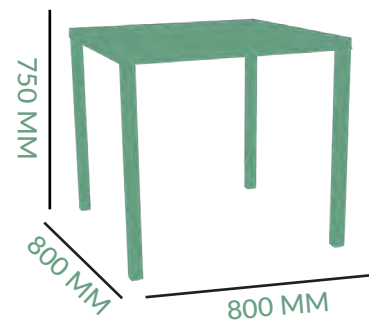

DIMENSIONS

 11.5 KG

**FRAME:** ALUMINUM WITH POLYPROPYLENE TOP

**COLOUR OPTIONS:**  
ANTHRACITE  
TAUPE  
WHITE

STACKABLE:

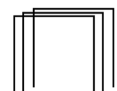

TESTED:



[VIEW TEST](#)

- SUPPLIED IN KD FORM
- POWDER COATED LEGS
- OTHER COLOURS AVAILABLE VIA INDENT

EXTRA INFORMATION

1400 TABLE

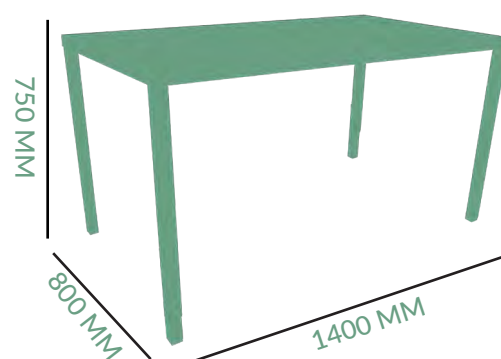

DIMENSIONS

 16.9 KG

**FRAME:** ALUMINUM WITH POLYPROPYLENE TOP

**COLOUR OPTIONS:**  
ANTHRACITE  
TAUPE  
WHITE

STACKABLE:

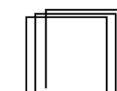

TESTED:



[VIEW TEST](#)

- SUPPLIED IN KD FORM
- POWDER COATED LEGS
- OTHER COLOURS AVAILABLE VIA INDENT

EXTRA INFORMATION

800 DRYBAR

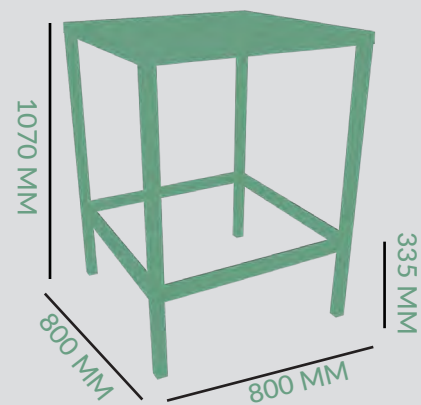

DIMENSIONS

 15.5 KG

**FRAME:** ALUMINUM WITH POLYPROPYLENE TOP

**COLOUR OPTIONS:**  
ANTHRACITE  
TAUPE  
WHITE

TESTED:



[VIEW TEST](#)

- SUPPLIED IN KD FORM
- UV ADDITIVES
- OTHER COLOURS AVAILABLE VIA INDENT

EXTRA INFORMATION

1400 DRYBAR

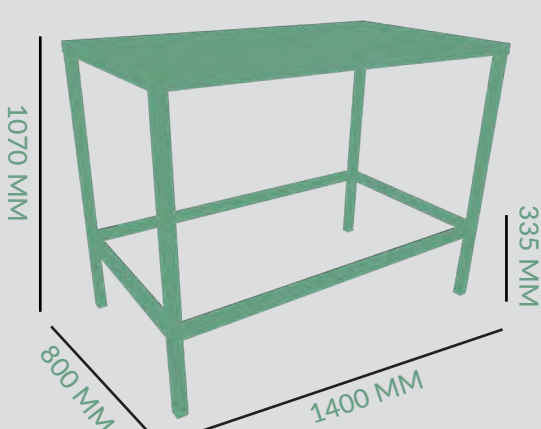

DIMENSIONS

 22.2 KG

**FRAME:** ALUMINUM WITH POLYPROPYLENE TOP

**COLOUR OPTIONS:**  
ANTHRACITE

TESTED:



[VIEW TEST](#)

- SUPPLIED IN KD FORM
- UV ADDITIVES
- OTHER COLOURS AVAILABLE VIA INDENT

EXTRA INFORMATION

TABLE

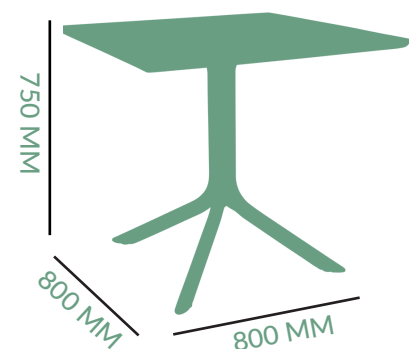

DIMENSIONS

 11.7 KG

**FRAME:** FIBREGLASS POLYPROPYLENE

**COLOUR OPTIONS:**  
ANTHRACITE  
TAUPE  
WHITE

TESTED:



[VIEW TEST](#)

- SUPPLIED IN KD FORM
- UV ADDITIVES
- OTHER COLOURS AVAILABLE VIA INDENT

EXTRA INFORMATION



TABLE

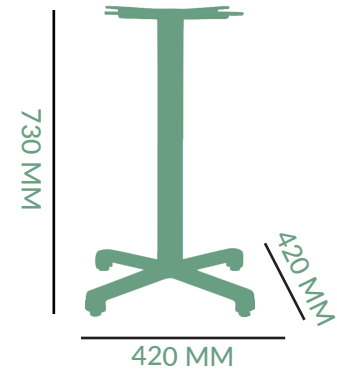

**11.2 KG**

**FRAME:** GALVANISED CAST IRON FEET  
**COLOUR OPTIONS:**  
ANTHRACITE  
WHITE

DIMENSIONS

**SQUARE:** 50 MM



\*ALUMINUM COLUMN AND BOOKER ROD ASSEMBLY

COLUMN

**FOOTPRINT:**

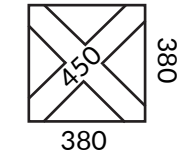

**HOLE DEPTH:** 8 MM

**TOP MAX:**

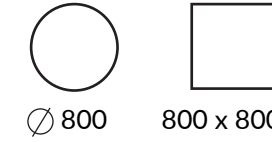

SPIDER

**FOOTPRINT:**

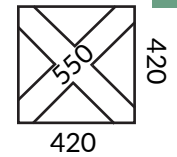

**ADJUSTABLE FOOTGLIDES:**

(THREAD M8 L10 MM) x 4

BASE

DRYBAR

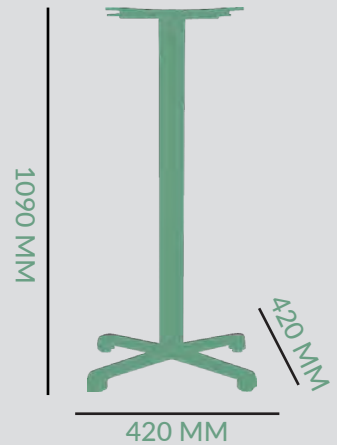

**12.7 KG**

**FRAME:** GALVANISED CAST IRON FEET  
**COLOUR OPTIONS:**  
ANTHRACITE  
WHITE

DIMENSIONS

**SQUARE:** 50 MM

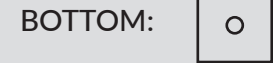
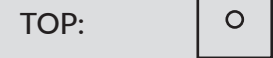

\*ALUMINUM COLUMN AND BOOKER ROD ASSEMBLY

COLUMN

**FOOTPRINT:**

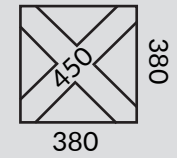

**SCREW DEPTH:** 8 MM

**TOP MAX:**



SPIDER

**FOOTPRINT:**

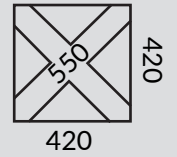

**ADJUSTABLE FOOTGLIDES:**

(THREAD M8 L10 MM) x 4

BASE

COFFEE TABLE

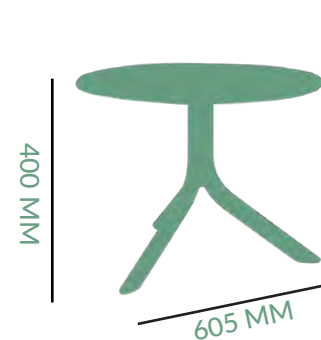

**3.9 KG**

**FRAME:** FIBREGLASS POLYPROPYLENE  
**COLOUR OPTIONS:**  
ANTHRACITE  
TAUPE  
WHITE

DIMENSIONS

**TESTED:** [VIEW TEST](#)

- SUPPLIED IN KD FORM
- UV ADDITIVES
- OTHER COLOURS AVAILABLE VIA INDENT

EXTRA INFORMATION

TABLE

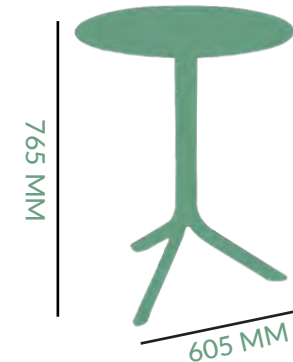

**4.2 KG**

**FRAME:** FIBREGLASS POLYPROPYLENE  
**COLOUR OPTIONS:**  
ANTHRACITE  
TAUPE  
WHITE

DIMENSIONS

**TESTED:** [VIEW TEST](#)

- SUPPLIED IN KD FORM
- UV ADDITIVES
- OTHER COLOURS AVAILABLE VIA INDENT

EXTRA INFORMATION

TABLE

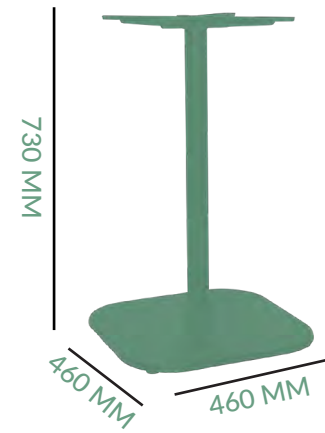

DIMENSIONS

15.8 KG

FRAME: ZINC COATED CAST IRON  
COLOUR OPTIONS:  
ANTHRACITE  
WHITE

DIAMETER: 50 MM



\*BOOKER ROD ASSEMBLY

COLUMN

FOOTPRINT:

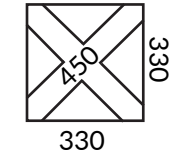

HOLE  
DEPTH: 7 MM

TOP MAX:

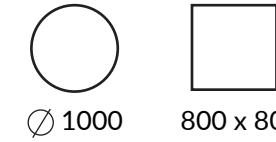

SPIDER

FOOTPRINT:



ADJUSTABLE FOOTGLIDES:

THREAD M8  
(L10 MM) x 4

BASE

BAR TABLE

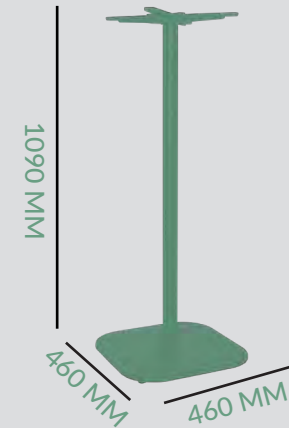

DIMENSIONS

17.5 KG

FRAME: ZINC COATED CAST IRON  
COLOUR OPTIONS:  
ANTHRACITE  
WHITE

SQUARE: 50 MM

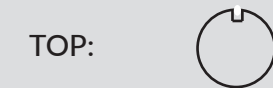

\*BOOKER ROD ASSEMBLY

COLUMN

FOOTPRINT:

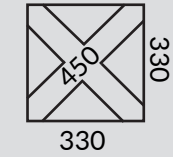

HOLE  
DEPTH: 7 MM

TOP MAX:

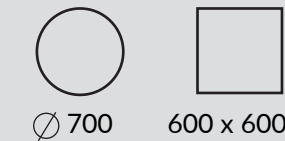

SPIDER

FOOTPRINT:



ADJUSTABLE FOOTGLIDES:

THREAD M8  
(L10 MM) x 4

BASE

TABLE

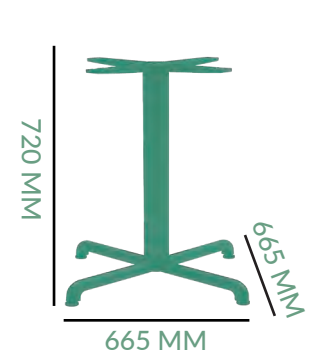

4.5 KG  
**FRAME:** COATED ALUMINIUM  
**COLOUR OPTIONS:**  
 ANTHRACITE  
 WHITE

DIMENSIONS

DIAMETER: 75 MM



\*BOOKER ROD ASSEMBLY

COLUMN

FOOTPRINT:

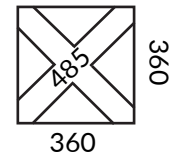

HOLE  
DEPTH: 7 MM

TOP MAX:

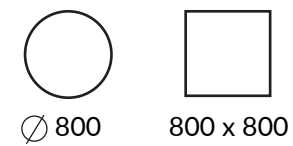

SPIDER

FOOTPRINT:

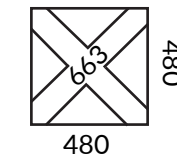

ADJUSTABLE FOOTGLIDES:

(THREAD M8  
L8 MM) x 4

BASE

BAR TABLE

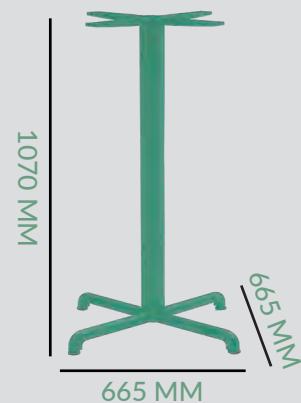

5.5 KG  
**FRAME:** COATED ALUMINIUM  
**COLOUR OPTIONS:**  
 ANTHRACITE  
 WHITE

DIMENSIONS

DIAMETER: 75 MM

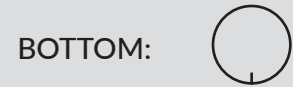
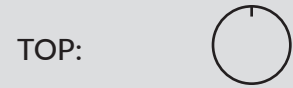

\*BOOKER ROD ASSEMBLY

COLUMN

FOOTPRINT:

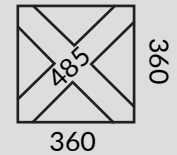

HOLE  
DEPTH: 7 MM

TOP MAX:

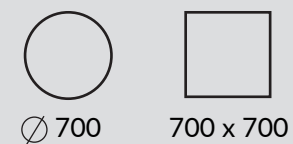

SPIDER

FOOTPRINT:

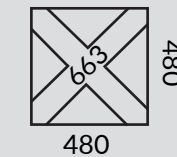

ADJUSTABLE FOOTGLIDES:

(THREAD M8  
L8 MM) x 4

BASE

TABLE



DIMENSIONS



FRAME: COATED ALUMINIUM  
COLOUR OPTIONS:  
ANTRACITE  
WHITE

DIAMETER: 75 MM



\*BOOKER ROD ASSEMBLY

COLUMN

FOOTPRINT:

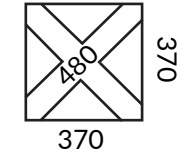

HOLE  
DEPTH: 7 MM

TOP MAX:

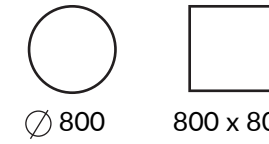

SPIDER

FOOTPRINT:

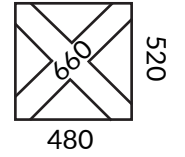

ADJUSTABLE FOOTGLIDES:

(THREAD M8  
L8 MM)  x 4

BASE

BAR TABLE

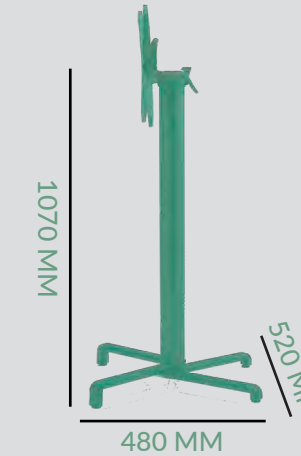

DIMENSIONS



FRAME: COATED ALUMINIUM  
COLOUR OPTIONS:  
ANTHRACITE  
WHITE

DIAMETER: 75 MM

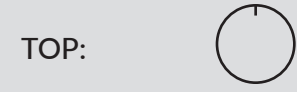

\*BOOKER ROD ASSEMBLY

COLUMN

FOOTPRINT:

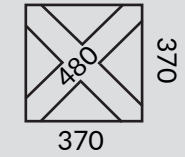

HOLE  
DEPTH: 7 MM

TOP MAX:



SPIDER

FOOTPRINT:

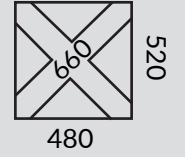

ADJUSTABLE FOOTGLIDES:

(THREAD M8  
L8 MM)  x 4

BASE

## TABLE

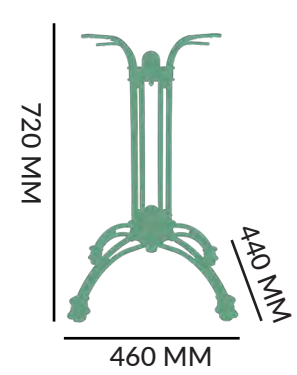

DIMENSIONS



5 KG

FRAME: CAST ALUMINUM

COLOUR OPTIONS:  
BLACK GLOSS

FOOTPRINT:

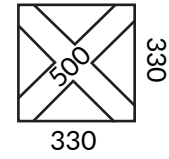
HOLE  
DEPTH: 10 MM

TOP MAX:

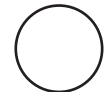

Ø 800



800 x 800

\*NOT SUITABLE FOR HEAVY TOPS  
SUCH AS STONE OR SOLID TIMBER.

TOP

FOOTPRINT:

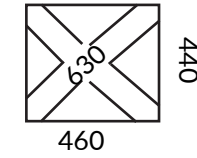

ADJUSTABLE FOOTGLIDES:

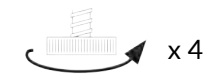
THREAD M8  
(L13 MM)

BASE

## HEAVY DUTY TABLE

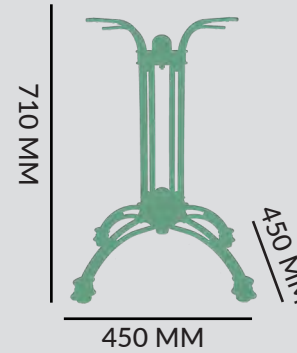

DIMENSIONS



8 KG

FRAME: CAST ALUMINUM

COLOUR OPTIONS:  
BLACK GLOSS

FOOTPRINT:

HOLE  
DEPTH: 10 MM

TOP MAX:



Ø 800



800 x 800

\*NOT SUITABLE FOR HEAVY TOPS  
SUCH AS STONE OR SOLID TIMBER.

TOP

FOOTPRINT:

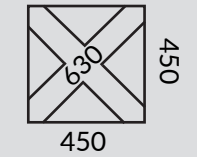

ADJUSTABLE FOOTGLIDES:

THREAD M8  
(L13 MM)

BASE

## DRYBAR

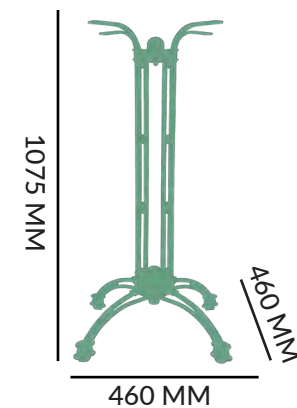

DIMENSIONS



7 KG

FRAME: CAST ALUMINUM

COLOUR OPTIONS:  
BLACK GLOSS

FOOTPRINT:

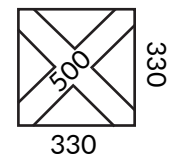
HOLE  
DEPTH: 10 MM

TOP MAX:

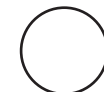

Ø 700



700 x 700

\*NOT SUITABLE FOR HEAVY TOPS  
SUCH AS STONE OR SOLID TIMBER.

TOP

FOOTPRINT:

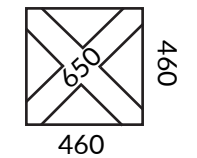

ADJUSTABLE FOOTGLIDES:

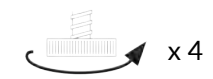
THREAD M8  
(L13 MM)

BASE

HEAVY/D DRYBAR

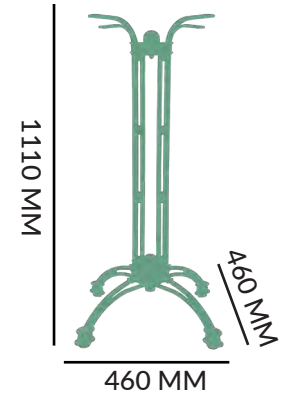

DIMENSIONS



10 KG

FRAME: CAST ALUMINUM

COLOUR OPTIONS:  
BLACK GLOSS

FOOTPRINT:

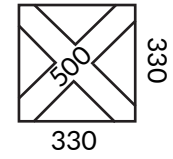

HOLE  
DEPTH: 10 MM

TOP MAX:

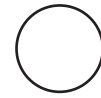

Ø 700



700 x 700

\*NOT SUITABLE FOR HEAVY TOPS  
SUCH AS STONE OR SOLID TIMBER.

TOP

FOOTPRINT:

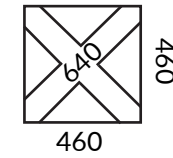

ADJUSTABLE FOOTGLIDES:

THREAD M8  
(L13 MM)



BASE

2 WAY TABLE

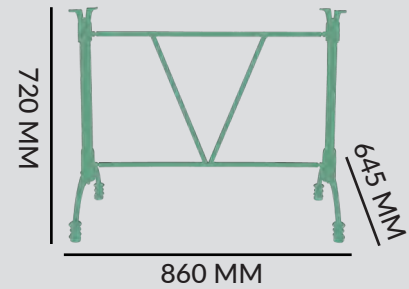

DIMENSIONS



6.7 KG

FRAME: CAST ALUMINUM

COLOUR OPTIONS:  
BLACK GLOSS

HOLE DEPTH: 10 MM

TOP MAX:



1200 x 800

\*NOT SUITABLE FOR HEAVY TOPS  
SUCH AS STONE OR SOLID TIMBER.

TOP

FOOTPRINT:

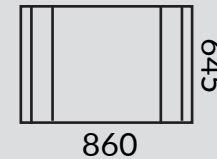

ADJUSTABLE FOOTGLIDES:

THREAD M8  
(L13 MM)



BASE

## TABLE

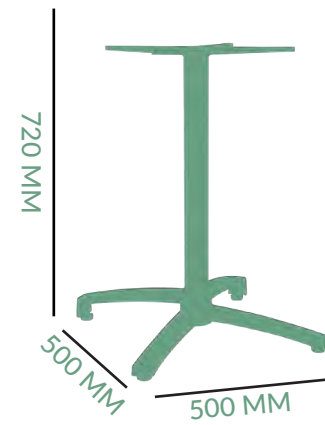

3 KG

FRAME: ALUMINIUM POWDERCOATED  
COLOUR OPTIONS:  
ANTHRACITE

## DIMENSIONS

DIAMETER: 60 MM

TOP:

BOTTOM:

\*BOOKER ROD ASSEMBLY

## COLUMN

FOOTPRINT:

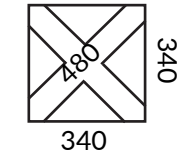
HOLE  
DEPTH: 7 MM

TOP MAX:

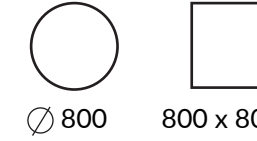

∅ 800 800 x 800

## SPIDER

FOOTPRINT:

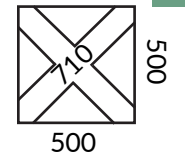

ADJUSTABLE FOOTGLIDES:

(THREAD M8  
L12 MM)  x 4

## BASE

## DRYBAR

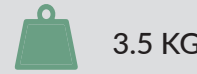
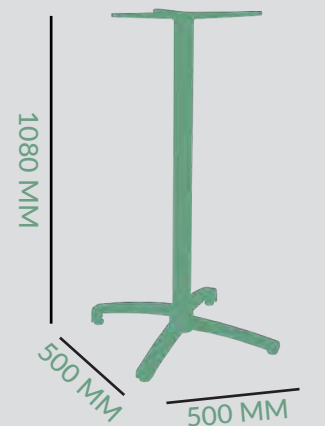

3.5 KG

FRAME: ALUMINIUM POWDERCOATED  
COLOUR OPTIONS:  
ANTHRACITE

## DIMENSIONS

DIAMETER: 60 MM

TOP:

BOTTOM:

\*BOOKER ROD ASSEMBLY

## COLUMN

FOOTPRINT:

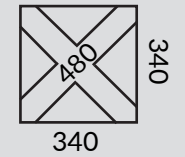
SCREW  
DEPTH: 7 MM

TOP MAX:

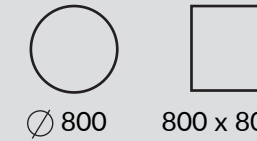

∅ 800 800 x 800

## SPIDER

FOOTPRINT:

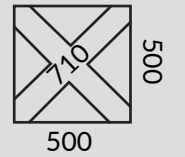

ADJUSTABLE FOOTGLIDES:

(THREAD M8  
L12 MM)  x 4

## BASE

## 2 WAY TABLE

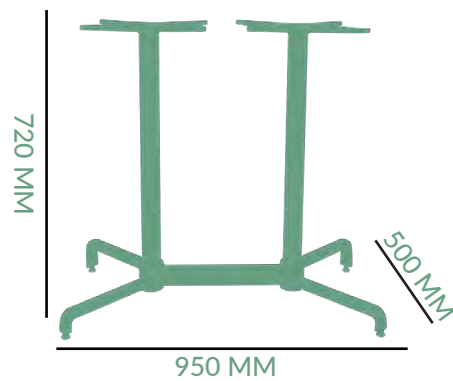

5.2 KG

FRAME: ALUMINIUM POWDERCOATED  
COLOUR OPTIONS:  
ANTHRACITE

## DIMENSIONS

DIAMETER: 60 MM

TOP:

BOTTOM:

\*BOOKER ROD ASSEMBLY

## COLUMN

FOOTPRINT:

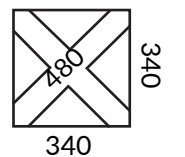
HOLE  
DEPTH: 7 MM

x 2

TOP MAX:



1200 x 800

## SPIDER

FOOTPRINT:

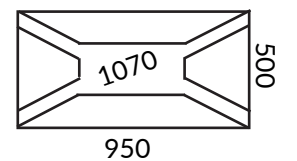

ADJUSTABLE FOOTGLIDES:

(THREAD M8  
L12 MM)  x 4

## BASE

## TABLE

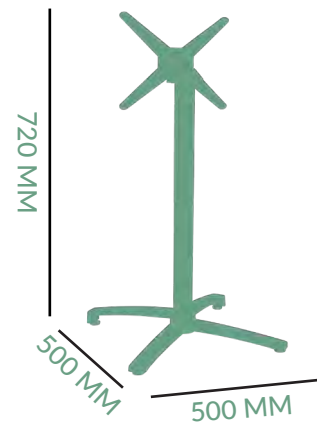

## DIMENSIONS

 3.7 KG

FRAME: ALUMINIUM  
POWDERCOATED

COLOUR OPTIONS:  
ANTHRACITE

DIAMETER: 60 MM

TOP: 

BOTTOM: 

\*BOOKER ROD ASSEMBLY

## COLUMN

FOOTPRINT:

HOLE  
DEPTH: 7 MM

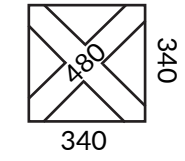

TOP MAX:

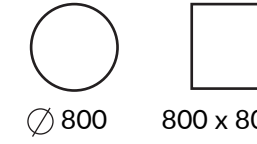

∅ 800 800 x 800

## SPIDER

FOOTPRINT:

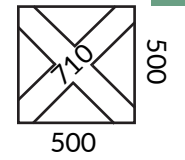

ADJUSTABLE FOOTGLIDES:

(THREAD M8  
L12 MM)  x 4

## BASE

## DRYBAR

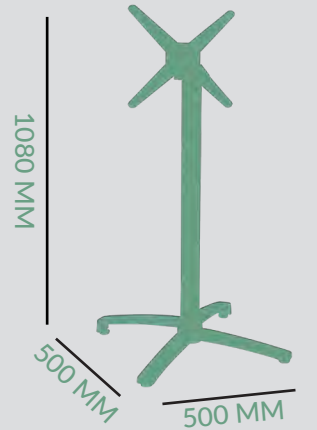

## DIMENSIONS

 4.1 KG

FRAME: ALUMINIUM  
POWDERCOATED

COLOUR OPTIONS:  
ANTHRACITE

DIAMETER: 60 MM

TOP: 

BOTTOM: 

\*BOOKER ROD ASSEMBLY

## COLUMN

FOOTPRINT:

SCREW  
DEPTH: 7 MM

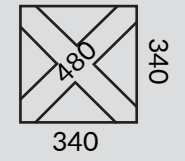

TOP MAX:



∅ 800 800 x 800

## SPIDER

FOOTPRINT:

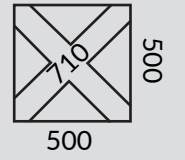

ADJUSTABLE FOOTGLIDES:

(THREAD M8  
L12 MM)  x 4

## BASE

## 2 WAY TABLE

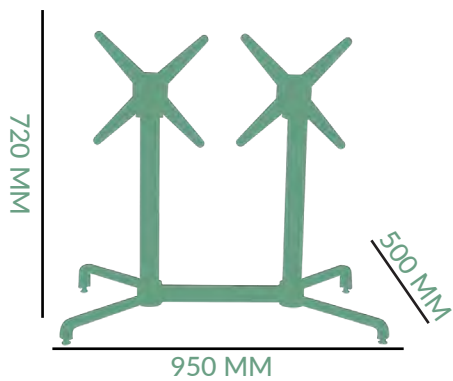

## DIMENSIONS

 6.6 KG

FRAME: ALUMINIUM  
POWDERCOATED

COLOUR OPTIONS:  
ANTHRACITE

DIAMETER: 60 MM

TOP: 

BOTTOM: 

\*BOOKER ROD ASSEMBLY

## COLUMN

FOOTPRINT:

HOLE  
DEPTH: 7 MM

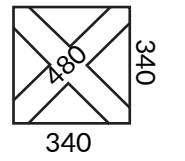

x 2

TOP MAX:

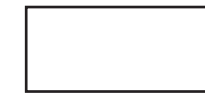

1200 x 800

## SPIDER

FOOTPRINT:

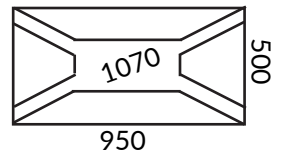

ADJUSTABLE FOOTGLIDES:

(THREAD M8  
L12 MM)  x 4